

# EFRATOM

Time & Frequency Products, Inc.

## OPERATION MANUAL

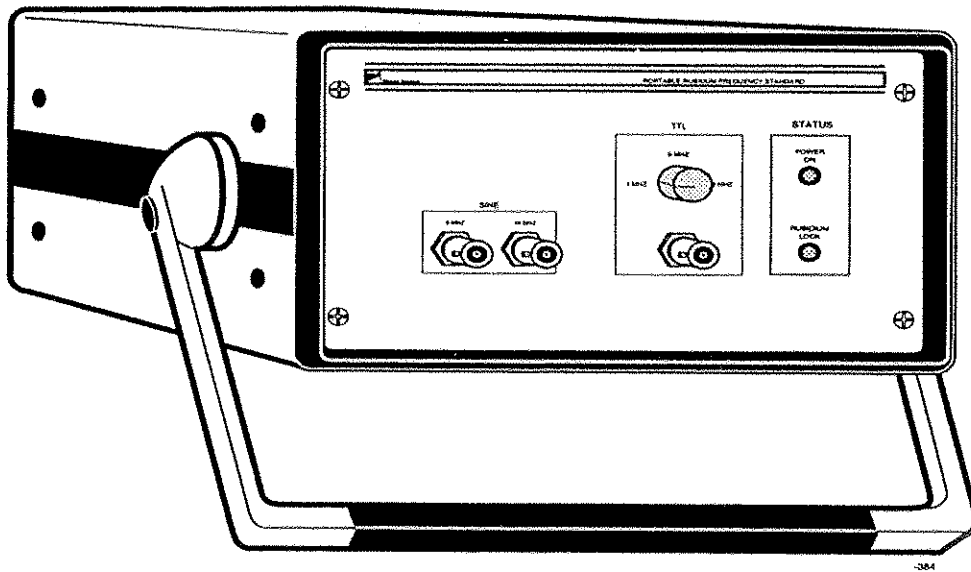

MODEL

PRFS

PORTABLE RUBIDIUM FREQUENCY STANDARD

# LIMITED WARRANTY

---

"The seller warrants that each article of goods sold by it will at the time of shipment be free from defects in materials furnished and workmanship performed by the seller. This warranty and seller's liability are limited to either granting credit or repairing or replacing, at seller's option, with reasonable promptness after return to seller of any article which is disclosed to seller's satisfaction to be defective, and only if said article is returned to the seller promptly after discovery of such defect and in no event later than *12 months* (or such other time period as may be specified in writing as a warranty period for a particular article) from the date of delivery thereof. Normal transportation charges in connection with an article returned shall be at the seller's expense, but only if the seller is responsible under the terms of this warranty. This warranty does not extend to any article which has been subject to misuse, neglect, or accident, nor does it extend to any article which has been repaired or altered by other than the seller. THIS WARRANTY IS IN LIEU OF ALL OTHER WARRANTIES EXPRESSED OR IMPLIED, INCLUDING ANY WARRANTY OF FITNESS FOR A PARTICULAR PURPOSE AND THE RIGHTS AND REMEDIES PROVIDED HEREIN ARE EXCLUSIVE AND IN LIEU OF ANY OTHER RIGHTS OR REMEDIES. IN NO EVENT SHALL SELLER BE LIABLE FOR CONSEQUENTIAL DAMAGES."

Efratom Time & Frequency Products, Inc. will be happy to answer any application or usage questions which will enhance your use of the unit. Please address your requests or correspondence to: EFRATOM Time & Frequency Products, Inc., 3 Parker, Irvine, California 92718-1696, Attention: Sales Department, or call (714) 770-5000, Fax: (714) 770-2463.

European customers may contact: Efratom Elektronik GmbH, Fichtenstr 25, 85649 Hofolding, Germany, Telephone: 08104-66240; Telex 529701; Fax: 08104-6622428.

# IMPORTANT

The following general safety precautions must be observed during all phases of the operation of this instrument. Failure to comply with these precautions violates safety standards of design, manufacture, and intended use of the instrument. *Efratom assumes no liability for the customer's failure to comply with these requirements.*

## GROUND THE INSTRUMENT

To minimize shock hazard, the instrument must be connected to an electrical ground. The instrument uses a three-conductor ac power cable. The power cable must either be plugged into an approved three-contact electrical outlet, or used with a three-contact to two-contact adapter with the grounding wire firmly connected to an electrical ground (safety ground) at the power outlet.

## DO NOT OPERATE IN AN EXPLOSIVE ATMOSPHERE

Do not operate the instrument in the presence of flammable gases or fumes.

## KEEP AWAY FROM LIVE CIRCUITS

Operating personnel should not remove instrument covers. Component replacement and internal adjustments should be made by qualified personnel. Do not replace components with power cables connected. To avoid injuries, always disconnect power from the unit.

## DO NOT SUBSTITUTE PARTS OR MODIFY INSTRUMENT

Because of the danger of introducing additional hazards, do not install substitute parts, or perform any unauthorized modification to the instrument. Return the instrument to Efratom for service and repair to ensure that safety features are maintained.

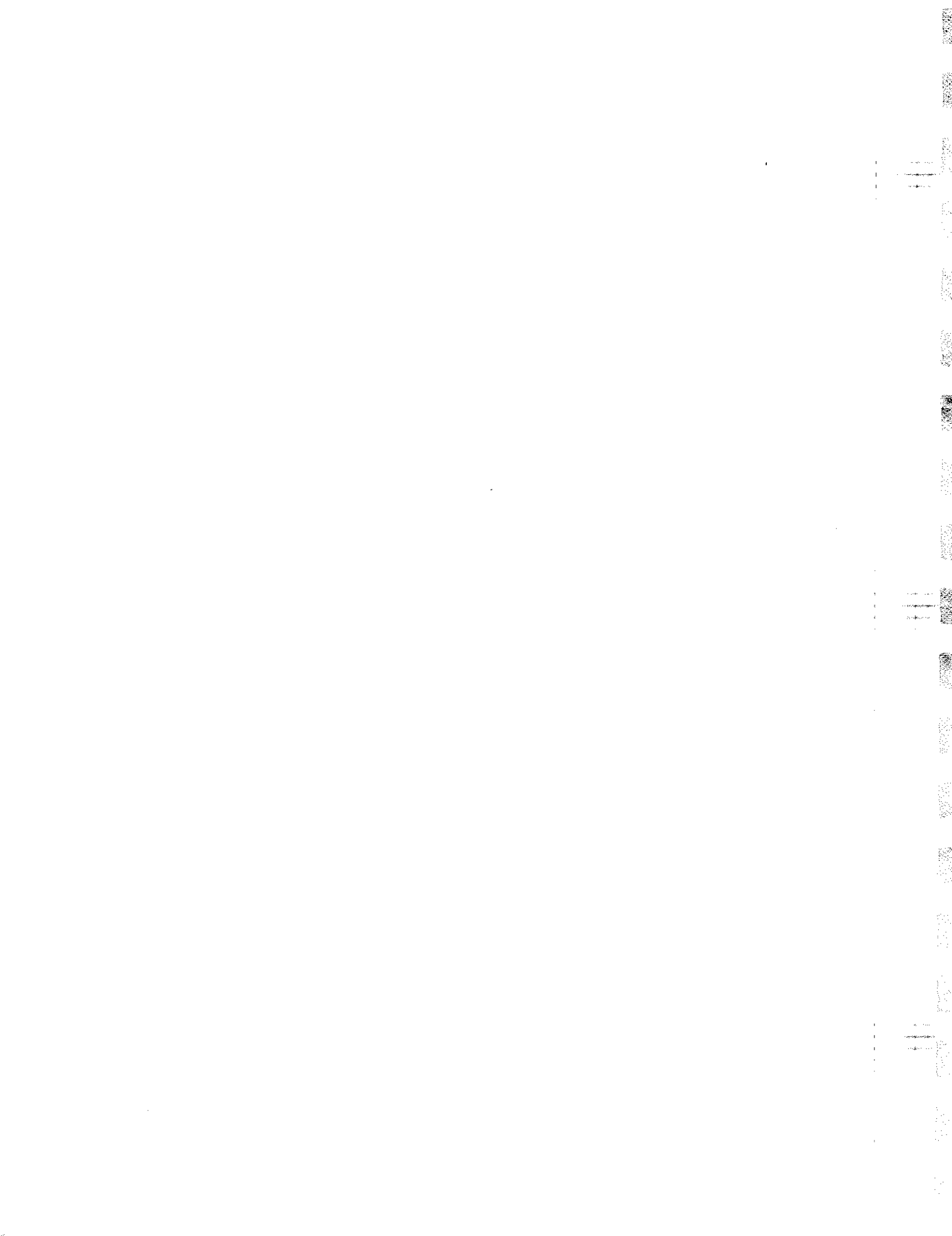

# TABLE OF CONTENTS

CHAPTER/PARAGRAPH	PAGE
<b>1. INTRODUCTION &amp; SPECIFICATIONS</b>	
1.1. Introduction	1-1
1.2. Manual Content	1-1
1.3. Output Frequency	1-1
1.4. Power Requirements	1-2
1.5. Supplied Accessories	1-2
1.6. Optional Accessories	1-2
1.7. Specifications	1-2
<b>2. INSTALLATION &amp; OPERATION</b>	
2.1. Introduction	2-1
2.2. Shipping and Receiving Information	2-1
2.3. Line Voltage	2-1
2.4. Installation Considerations	2-1
2.5. Installation	2-1
2.6. Controls, Indicators, and Connections	2-2
2.7. Operating Instructions	2-2
2.8. Operational Checks	2-2
<b>3. THEORY OF OPERATION</b>	
3.1. Introduction	3-1
3.2. Simplified Block Diagram	3-1
3.3. Rubidium (Rb) Oscillator	3-1
3.4. Power Supply	3-1
3.5. Frequency Dividers and Buffer Amplifiers	3-2
3.6. Operation Indicators	3-2
<b>4. MAINTENANCE</b>	
4.1. Introduction	4-1
4.2. Field Maintenance	4-1
4.3. Performance Tests	4-1
4.4. Test Equipment	4-1
4.5. Normal Operation	4-1
4.6. Functional Operation Test Equipment	4-2
4.7. Operational frequency Accuracy Test	4-2
4.8. Short Term Stability Test (Allan Variance)	4-3

# TABLE OF CONTENTS (continued)

## LIST OF ILLUSTRATIONS

FIG.	TITLE	PAGE
1-1.	Portable Rubidium Frequency Standard (PRFS)	1-1
2-1.	Front panel Controls, Connectors, and Indicators	2-3
2-2.	Rear Panel Controls, Connectors, and Indicators	2-3
3-1.	PRFS Block Diagram	3-2
4-1.	Operational Frequency Accuracy Test Set-up	4-2

## LIST OF TABLES

TABLE	TITLE	PAGE
2-1.	Controls, Indicators, and Connectors	2-2
4-1.	Operations Test Equipment	4-2

## APPENDICES

Appendix A: Schematic Diagram

Appendix B: Power Supply

# SECTION 1

## INTRODUCTION AND SPECIFICATIONS

### 1.1 INTRODUCTION

The Efratom Model PRFS Rubidium (Rb) Frequency Standard is one of Efratom's family of Frequency Standards/Test Instruments. The PRFS is a compact, self-contained, portable frequency standard that can provide an extremely pure and stable sinusoidal signal at frequencies of 5 and 10 MHz, and one (switchable) 1, 5, or 10 MHz TTL. The heart of the PRFS unit is an Efratom model FRS-C, a compact 10 MHz Atomic Oscillator. The PRFS has been designed to be used as a Master Oscillator in laboratories and for field calibration services.

### 1.2 MANUAL CONTENT

The PRFS manual contains information regarding the operation of the PRFS Frequency Standard, and treats the internal Rb oscillator as a module. A copy of the FRS Operation Manual is provided with each unit. This manual contains information regarding the operation and operation tests pertaining to the internal Rb standard. The schematic and assembly drawings and parts list for the PRFS are included in the appendix of this manual. The schematics and assembly drawings pertaining to the FRS Rb oscillator are included in the FRS Operation Manual.

### 1.3 OUTPUT FREQUENCY

The PRFS provides three output connectors on the front panel with a 5 and 10 MHz output signal and one (switchable) 1, 5, or 10 MHz TTL. The output level is approximately 1.0 V<sub>rms</sub> ( $0.85 \pm 0.25$  V<sub>rms</sub>) when terminated with a 50 ohm resistive load.

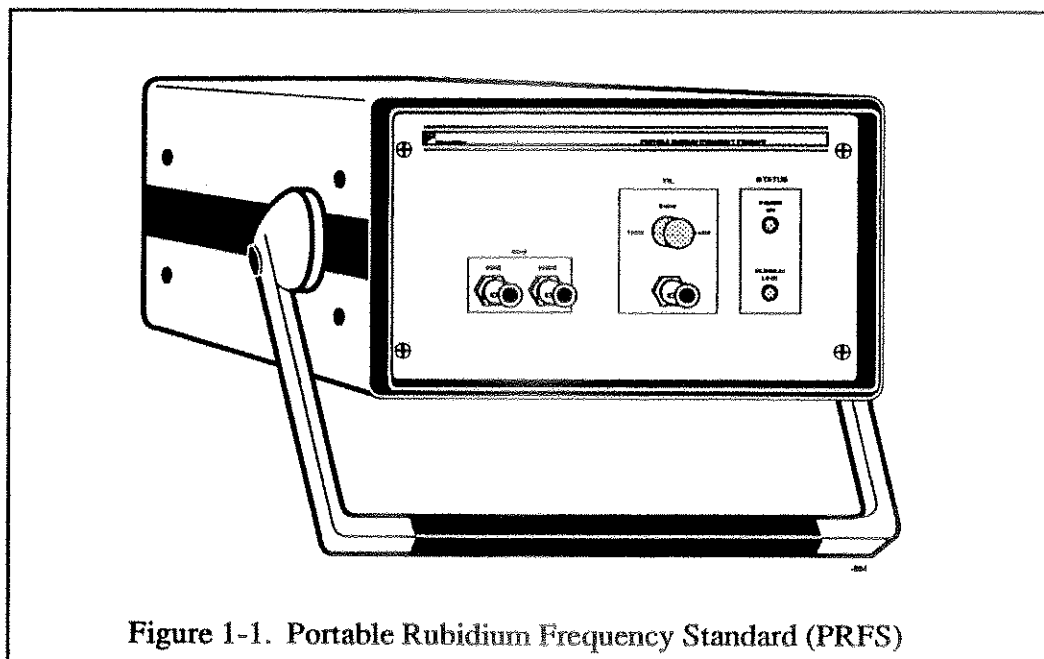

Figure 1-1. Portable Rubidium Frequency Standard (PRFS)

## 1.4 POWER REQUIREMENTS

The PRFS can be operated from either 115/220 Vac source at 47-400 Hz,  $\leq 25$  watts, steady state without changing the internal wiring of the unit.

## 1.5 SUPPLIED ACCESSORIES

The accessories supplied with the PRFS include the following:

- 1) AC line cord, Switchcraft, P/N 91-T-3261-1.
- 2) Fuse - 3A, 250 V, 3AG Slo-Blo Type.

## 1.6 OPTIONAL ACCESSORIES

The following accessories may be ordered from Efratom:

- 1) Spare fuses.

## 1.7 SPECIFICATIONS

The pertinent technical specifications for the PRFS are listed below:

### Electrical Performance:

<b>Outputs</b>	10 MHz sine 5 MHz sine 1, 5, or 10 MHz TTL (switchable)
<b>Sine Outputs Level/Loads (Ohms)</b>	$0.85 \pm 0.25$ Vrms (50 $\Omega$ )
<b>Phase Noise (SSB 1 Hz BW)</b>	>110 dB @ 100 Hz from carrier >130 dB @ 1000 Hz from carrier
<b>Harmonic/Non-Harmonic Distortion</b>	>30 dBc (sine) / -65 dBc
<b>Aging</b>	5E-11/month (After 1 month of continuous operation)
<b>Frequency Accuracy at Shipment</b>	$\pm 5E-11$ (25°C)



*Portable Rubidium Frequency Standard*

<b>Frequency Retrace</b>	5E-11 (After 1 hour power on @ 25°C & up to 24 hours power off)
<b>Short-Term Stability</b>	1E-10, t = 1 sec 3.16E-11, t = 10 sec 1E-11, t = 100 sec
<b>Trim Range</b>	2E-9 nominal
<b>Setting Resolution</b>	1E-11
<b>Warm-up Characteristics</b>	<6 minutes to reach 1E-9 @ 25°C ambient
<b>Input Power</b>	25 W at 115/220 Vac  47-440 Hz (Fused)
<b>Environmental Specifications:</b>	
<b>Operating Temp. Range</b>	<3E-10 from 0°C to +50°C (Ambient)
<b>Storage Temp.*</b>	-40°C to + 60°C
<b>Altitude</b>	1E-13/mbar (sea level to 40,000 ft.)
<b>Magnetic Field Sensitivity</b>	≤ 4E-13/AM <sup>-1</sup> (worst case) (3E-11/gauss)
<b>Relative Humidity</b>	95%
<b>Weight</b>	<15.0 lbs.
<b>Size</b>	5.79 in. high x 10.13 in. wide x 11.38 in. long. (length doesn't include portable handle)
<b>Controls/Indicators</b>	Power (GRN) and Rb Lock (GRN) LED indicators Power ON/OFF switch
<b>Warranty</b>	1 year

---

\* will not start up in temperatures below -10°C.



## SECTION 2

### INSTALLATION AND OPERATION

#### 2.1 INTRODUCTION

This section of the manual contains installation and operation information for the Efratom Model PRFS Rubidium Frequency Standard. It is recommended that this section be read completely prior to operation of the unit.

#### 2.2 SHIPPING AND RECEIVING INFORMATION

The PRFS is packaged and shipped in a foam-packed container. The unit was inspected mechanically and electrically prior to its shipment. Upon receipt of the instrument make a thorough inspection to ensure that damage has not occurred during shipping. If damage is discovered, contact Ball Corporation, Efratom Division, 3 Parker, Irvine, CA 92718-1605. Telephone (714) 770-5000. If reshipment of the unit is necessary, use the original container and packing. If the original container is not available, a suitable container with foam packing is recommended.

#### 2.3 LINE VOLTAGE

The PRFS operates from either a 115 or 220 Vac power source @ 47-440 Hz. The power supply will adjust automatically from 115 or 220 Vac without having to modify the internal jumpers of the power supply.

#### 2.4 INSTALLATION CONSIDERATIONS

The PRFS should not be installed near equipment generating strong magnetic fields such as generators, transformers, etc. Also, care should be taken to ensure that the maximum operating temperature is not exceeded (50°C ambient).

#### 2.5 INSTALLATION

The PRFS as shipped can be benchtop operated.

At +25°C the Rb oscillator locks in  $\leq 10$  minutes with a stabilization period during which the system reaches thermal equilibrium (~1 hour). Refer to Sections 2.9 and 2.10 for information on operating instructions and operational checks.

## 2.6 CONTROLS, INDICATORS, AND CONNECTORS

The PRFS front panel and rear panel are illustrated in Figures 2-2 and 2-3 respectively. Table 2-1 provides a brief functional description of each control, indicator, and connector.

Table 2-1: Controls, Indicators, and Connectors

ITEM	NOMENCLATURE	FUNCTIONAL DESCRIPTION
1	5 MHz Output	Provides 5 MHz output signal. The connector is a BNC female type.
2	10 MHz Output	Provides 10 MHz output signal (BNC connector)
3	Switchable Output	Provides output signals of 1, 5, 10 MHz TTL.
4	S1	Allows selection of 1, 5, or 10 MHz TTL output
5	POWER ON	When lit (GRN), indicates that the input power is being supplied to the unit from an ac source.
6	Rb LOCKED Indicator	When lit (GRN), indicates that the Rb oscillator is locked to the rubidium frequency.
7	Receptacle	Accepts ac line cord to provide 115 Vac-220 Vac operation.
8	POWER 1/0	Disconnect/connects the unit to ac power.

## 2.7 OPERATING INSTRUCTIONS

When ac power cord is plugged into a wall outlet and the ON/OFF switch on the back panel is switched to the 1 position, ac power is supplied to the PRFS unit, the front panel POWER indicator (GREEN) will illuminate and the Rb LOCK light will blink during warm-up. Within six minutes the Rb LOCK light should illuminate, indicating that the voltage controlled crystal oscillator (VCXO) has become frequency locked to the rubidium atomic reference. The unit is fully operational at this time.

## 2.8 OPERATIONAL CHECKS

Operation checks should be performed on the FRS module of the PRFS unit if the Rb LOCK LED does not illuminate within 10 minutes. These checks are normally done every 6 to 12 months. Refer to Section 4 for instructions on how to perform operational checks.

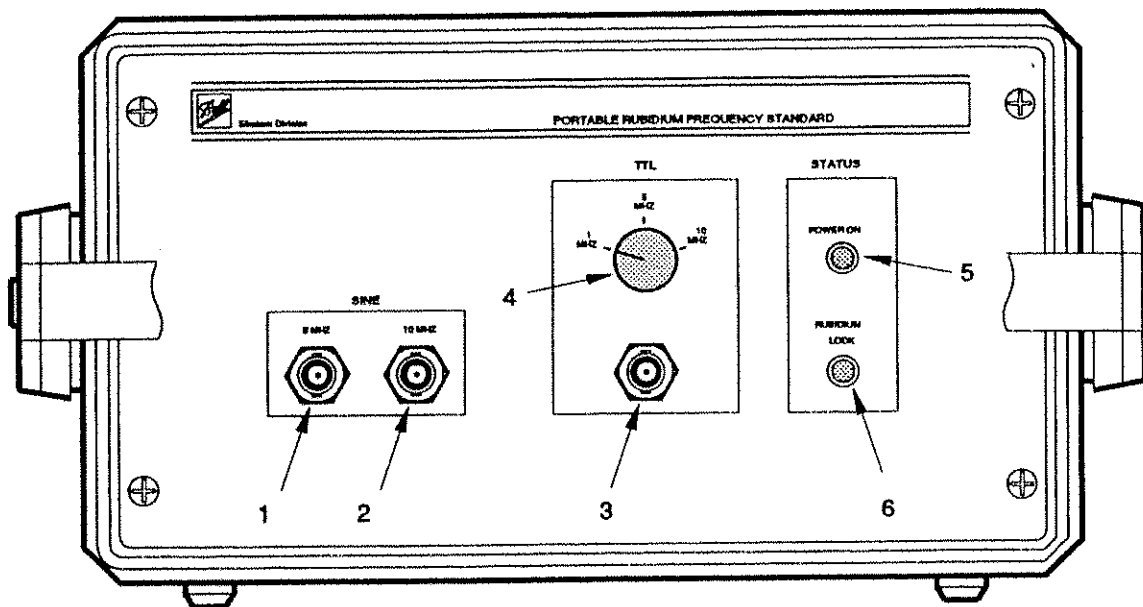

FIGURE 2-1: FRONT PANEL CONTROLS, CONNECTORS, AND INDICATORS

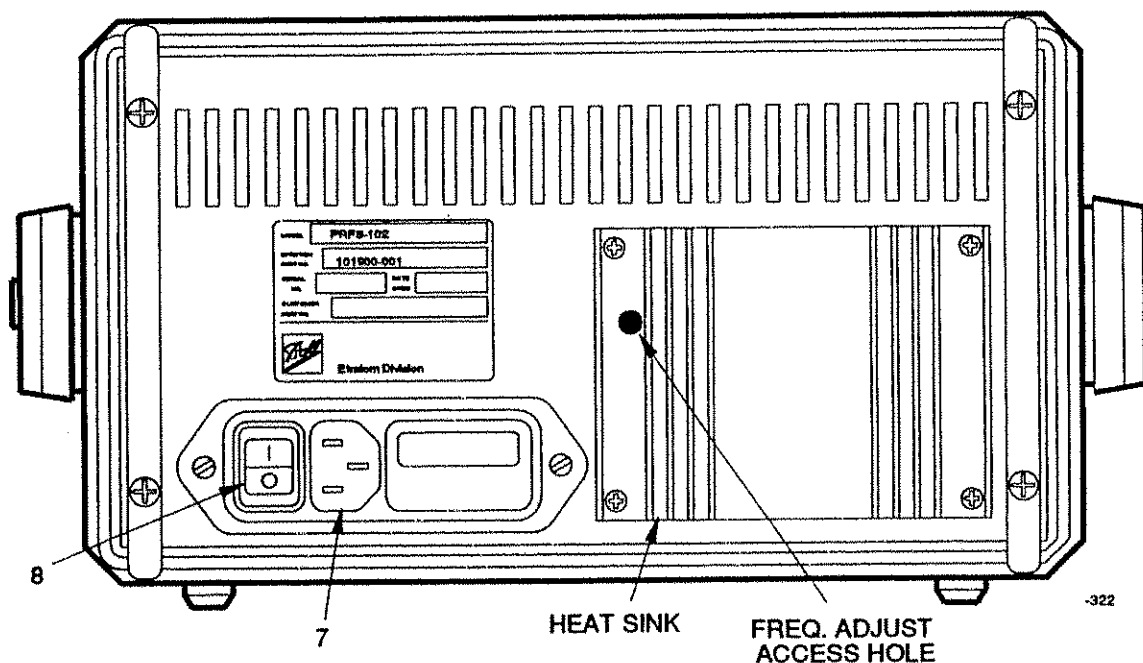

FIGURE 2-2: REAR PANEL CONTROLS, CONNECTORS, AND INDICATORS



## SECTION 3

### THEORY OF OPERATION

#### 3.1 INTRODUCTION

This section of the manual contains a general theory of operation, block diagram analysis, and detailed description of the PRFS circuits (excluding the Model FRS Rb Oscillator, which is covered in the FRS manual). A simplified block diagram (Figure 3-1) is included to help clarify the text. Schematic diagrams are included in Appendix A to allow a detailed circuit analysis.

#### 3.2 SIMPLIFIED BLOCK DIAGRAM

As shown in Figure 3-1, the PRFS contains a Rb oscillator (A1), an ac plug and filter circuitry, and a 2 amp power supply (A2).

#### 3.3 RUBIDIUM (Rb) OSCILLATOR A1

The frequency standard used with the PRFS is an Efratom FRS-C Rb Oscillator. The Rb oscillator provides the primary 10 MHz TTL output signal. For a more complete understanding of the operation of the FRS Rubidium refer to the Theory of Operation section of the FRS manual.

#### 3.4 POWER SUPPLY A2

The internal dc power supply converts the 115/220 Vac line voltage into 24 Vdc levels for proper operation. Refer to the supplied Lambda LFS-41-24 power supply manual for information on the PRFS power supply (Appendix C).

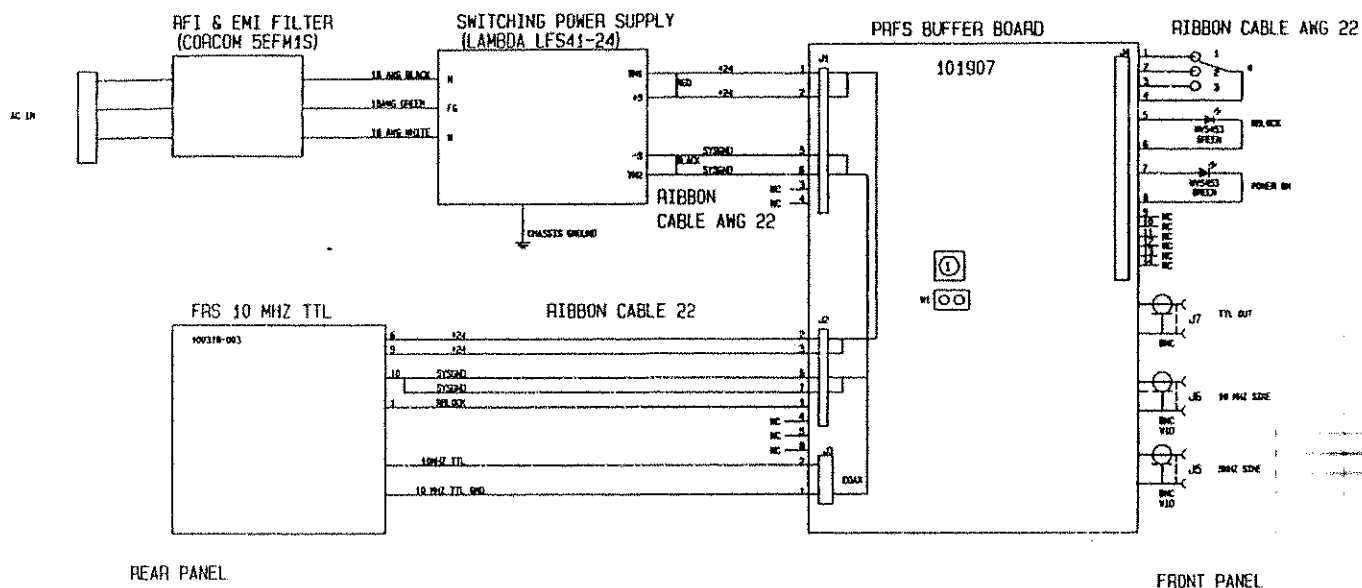

Figure 3-1: PRFS Block Diagram

### 3.5 FREQUENCY DIVIDERS AND BUFFER AMPLIFIERS (A3)

The 10 MHz TTL output signal from the internal FRS Rb oscillator is used as the system clock. The system clock drives U3 which generates the 1, 5, and 10 MHz TTL signals. Depending on the switch selection, U3 pin 15 will generate one of the 1, 5, or 10 MHz TTL outputs. The output of U3 is routed to the J7 connector through U4, the 50 Ω TTL buffer.

If the rubidium oscillator is not locked, then U3 stops generating output to prevent the use of an inaccurate signal. To override this feature, install jumper U11 across 1 and 2.

The above discussion also covers the 5 MHz and the 10 MHz sinewave outputs at J5 and J6 respectively. U1 divides the system clock to a 5 MHz TTL signal. The output of U1 is routed through the 5 MHz bandpass filter and the 50 Ω line driver circuits to J5.

U2 pin 11 passes the system clock to the 10 MHz bandpass filter and the 50 Ω line driver circuits to J6.

### 3.6 OPERATION INDICATORS

While the PRFS is warming up, prior to the VCXO locking-on the atomic resonance frequency, the Rb LOCK indicator will blink. When the VCXO is locked onto the atomic reference frequency, the Rb LOCK indicator will illuminate.



## SECTION 4

### MAINTENANCE

#### 4.1 INTRODUCTION

This portion of the manual provides procedures for performance tests on the PRFS. If the unit requires service, contact Ball Corporation, Efratom Division for repairs.

#### 4.2 FIELD MAINTENANCE

Field maintenance is limited by the test equipment available and the skill level of the maintenance personnel. Normal field maintenance is restricted to frequency adjustment. If more extensive service is required, the unit should be returned to the factory to ensure proper repair.

#### 4.3 PERFORMANCE TESTS

Performance tests can be performed on the PRFS to ensure that the unit is operating normally.

Performance tests include the following:

- a) Output Frequency Offset Test.
- b) Long-Term Stability Tests (Drift).

#### 4.4 TEST EQUIPMENT

The required test equipment to ensure normal operation is listed in Table 4.1. Test equipment other than those items listed may be used, providing that the substitute equipment meets or exceeds the "Minimum Use Specifications" as listed in Table 4.1. If the required test equipment or a substitute is not available, it is recommended that the unit be sent back to the Efratom factory for service.

#### 4.5. NORMAL OPERATION

When 24 Vdc is applied to pins 9 and 6(+) and 10(-), the unit will immediately begin generating a 10 MHz signal from the crystal oscillator. Within approximately 4 to 6 minutes after application of input power, the unit will "lock". The crystal is now stabilized by the atomic resonant frequency.

#### 4.6. FUNCTIONAL OPERATION TEST EQUIPMENT

The equipment required to functionally test the unit is listed in Table 4-1. Test equipment other than those items listed may be used provided that the performance equals or exceeds the MINIMUM USE CHARACTERISTICS as stated in Table 4-1.

TABLE 4-1. Operations Test Equipment

Para. No.	ITEM	MINIMUM USE CHARACTERISTICS	TEST EQUIP.
4.2	Freq. & Time Interval Analyzer	Ref. Freq. 10 MHz Resolution: 1E-10	Hewlett-Packard 5371A
4.3	Optional External Freq. Ref.	Output Frequency: 10 MHz Accuracy: $\pm 5E-12$ Stability: Parts in $10^{12}$ , or as req.	Cesium standard

**NOTE**

Throughout the test procedures in this manual the PRFS will be referred to as the UUT (Unit Under Test). In addition, connections described or illustrated pertain to J2 BNC connector.

#### 4.7 OPERATIONAL FREQUENCY ACCURACY TEST

- a) Connect the equipment as shown in Figure 4-1.

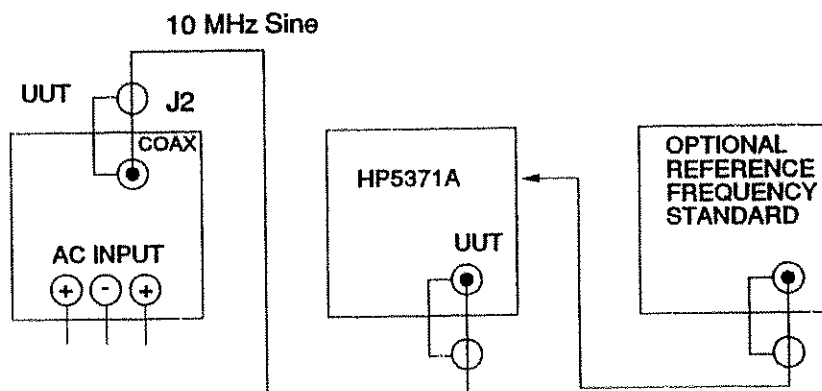

Figure 4-1. Operational Frequency Accuracy Test Setup.

**NOTE**

The UUT requires 6 minutes (@ 25°C) to stabilize to  $\pm 1\text{E-}9$  if <24 hours have elapsed since prior operation and the unit has been calibrated recently. The maximum frequency offset after 1 hour operation would be  $\pm 2\text{E-}11$  warm-up accuracy,  $\pm 2\text{E-}11$  retrace. This assumes the last calibration was at the same ambient temperature.

- c) Begin the test (refer to Frequency & Time Analyzer or HP5371A manuals).
- d) Allow sufficient time for the test set to indicate the UUT OFFSET for the data you require. Verify that the UUT frequency offset is within the tolerance (see specifications).

**4.8 SHORT TERM STABILITY TEST (ALLAN VARIANCE)**

**NOTE**

If steps 4-7a through 4-7d have been completed, and the Allan Variance indications (as displayed on the HP-5371A) are of the required averaging times, the test results as indicated are valid. If 4.7 was not performed, continue with 4.8.

- a) With the equipment connected as shown in Figure 4-1, and the required stabilization time allowed, (refer to NOTE following 4.7b), begin the test.
- b) Allow sufficient time for the test set to display the data for the averaging times required, and verify that the UUT Allan Variance is within the tolerance listed in Section 1, SPECIFICATIONS.
- c) If no other tests are necessary, disconnect the test set-up.



## APPENDIX A

### LIST OF DRAWINGS

DRAWING NO.	DESCRIPTION	PAGE NO.
101961-001	Wiring/Block Diagram, PRFS	A-1
101905	Schematic, Buffer Board	A-2
101907-001	Buffer Board Assembly	A-3
PL101907-001	Parts List, Buffer Board Assembly	A-4
101900-001	Final Assembly, PRFS	A-5
PL101900-001	Parts List, Final Assembly	A-6



① INSTALL JUMPER W1 TO OVERRIDE THE RUBIDIUM LOCK SIGNAL

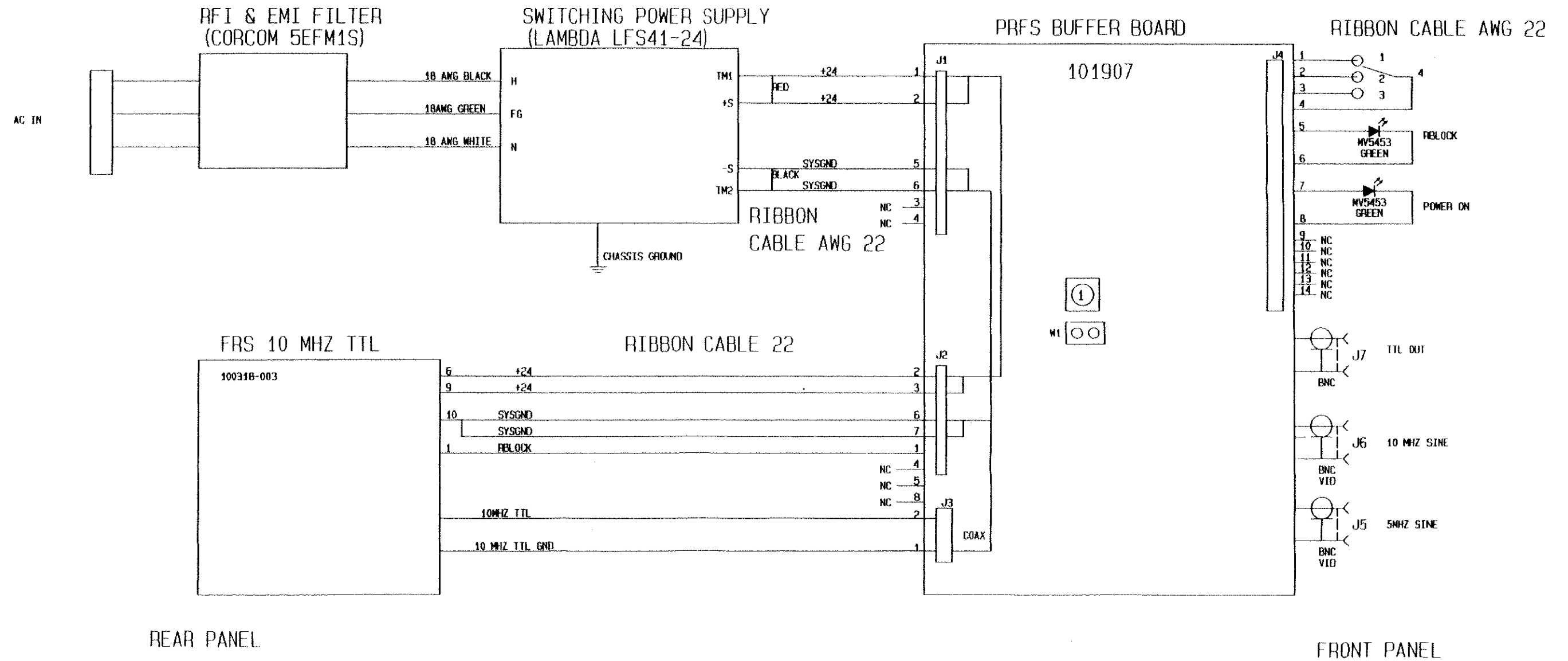

Wiring/Block Diagram PRFS (101961)

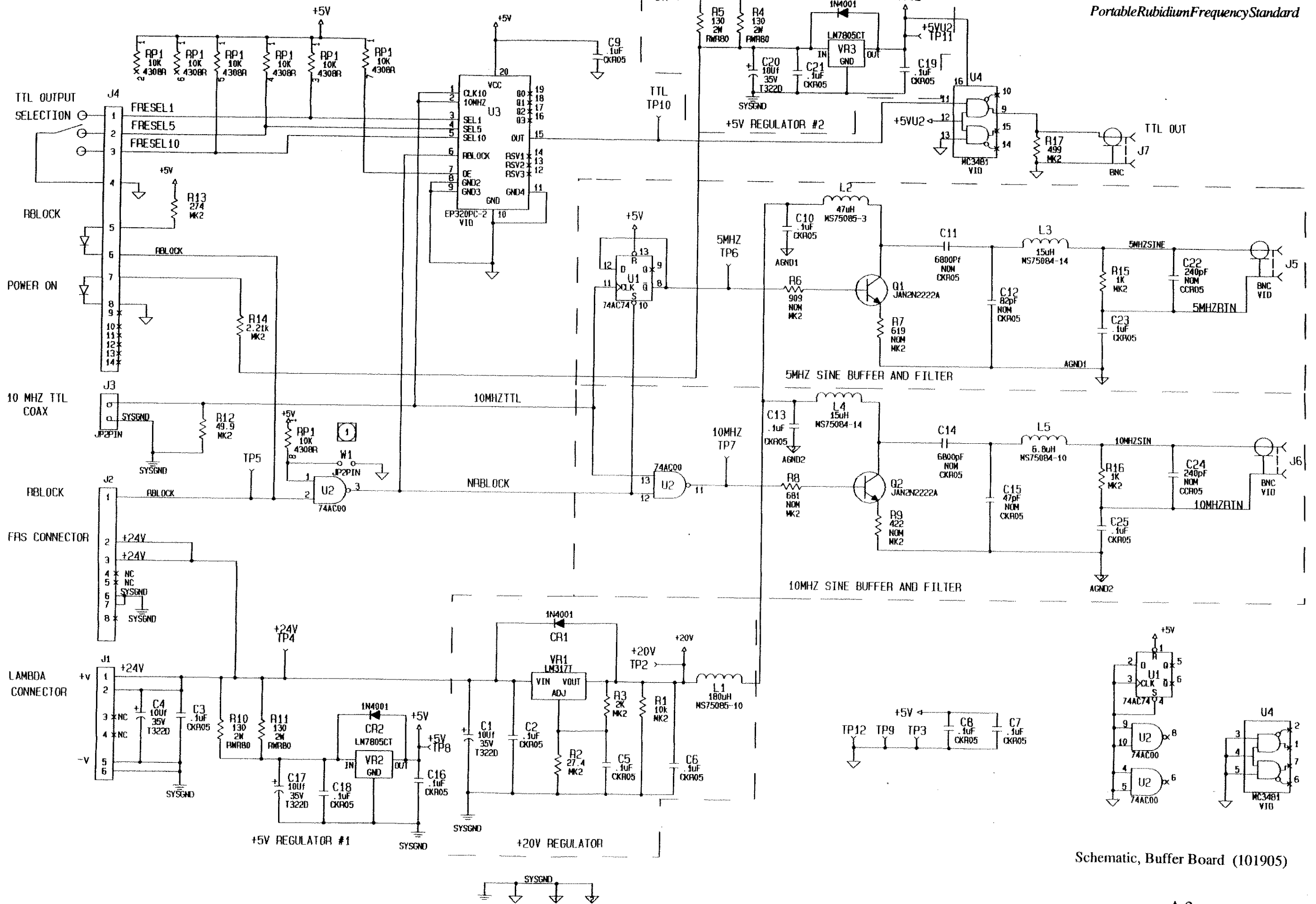

Schematic, Buffer Board (101905)



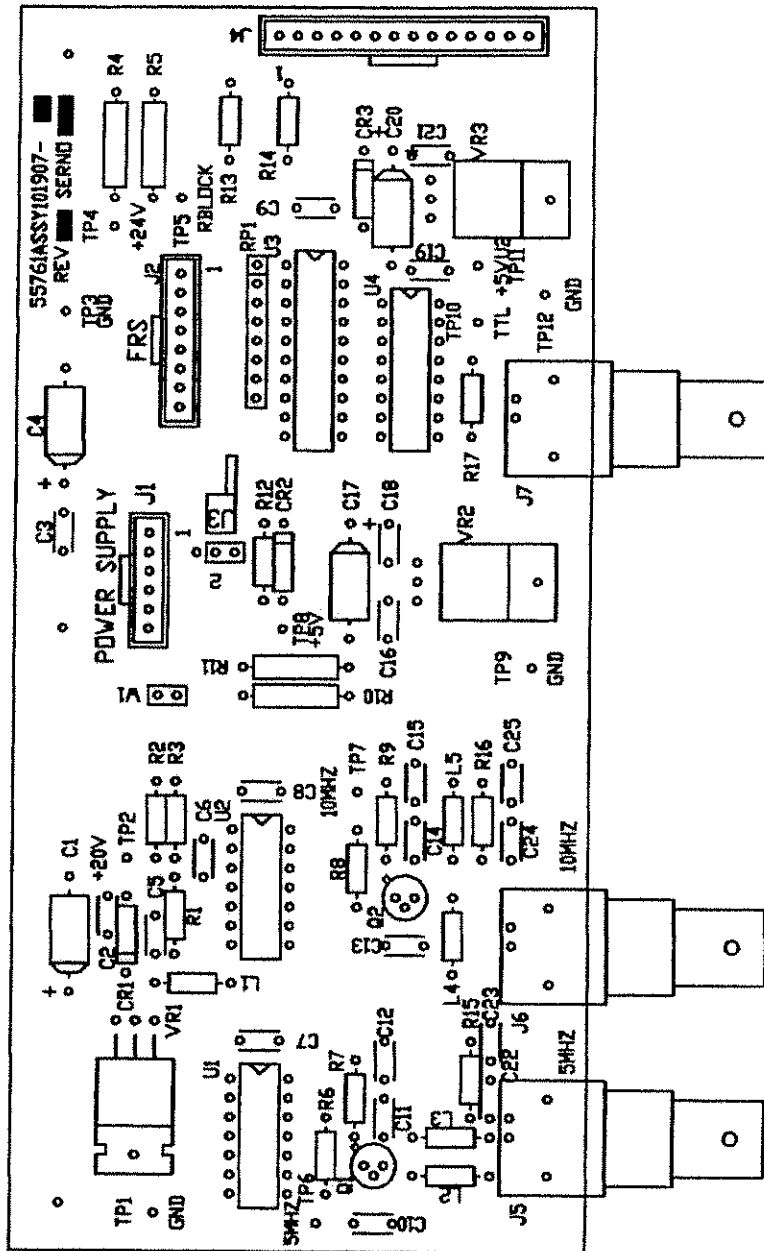

Buffer Board Assembly (101907-001)

*Portable Rubidium Frequency Standard*

FIND NO.	QTY	CAGE CODE	PART OR IDENTIFYING NO.	SPEC. OR MANUFACTURER	NDMENCLATURE OR DESCR.	HCI CODE	REFERENCE DESIGNATOR
1	1		101906-001	101906	CIRCUIT CARD, PRFS		
2	1		101912-001	101912	MICROCIRCUIT, PROGRAMMED		U3
3	1		MS75085-3	MIL-C-15305	INDUCTOR, 47UH		L2
4	2		MS75084-14	MIL-C-15305	INDUCTOR, 15UH		L3, L4
5	1		MS75084-10	MIL-C-15305	INDUCTOR, 6.8UH		L5
6	1		MS75085-10	MIL-C-15305	INDUCTOR, 180UH		L1
7	15		CKR05BX104KSV	MIL-C-39014	CAPACITOR, CER, X7R, .1UF, 50V, 10%		C2, C3, C5-C10, C13, C16, C18, C19, C21, C23, C25
8	2		CCR05CG241JR	MIL-C-20	CAPACITOR, CER, 240PF, 5%		C22, C24
9	2		CKR05BX682KSV	MIL-C-39014	CAPACITOR, CER, X7R, 6800pf, 100V, 10%		C11, C14
10	1		CKR05BX820KS	MIL-C-39014	CAPACITOR, CER, .82PF		C12
11	1		CKR05BX470KSV	MIL-C-39014	CAPACITOR, CER, 47PF, 10%		C15
12	2		MK2 1K	STETTNER	RESISTOR, MF, 1.00K OHM, 1/4W, 1%, 50ppm/C		R15, R16
13	1		MK2 909	STETTNER	RESISTOR, 909 OHM, 1/4W, 1%	R6	NOTE: (1) THE FOLLOWING COMPONENT
14	1		MK2 619	STETTNER	RESISTOR, 619 OHM, 1/4W, 1%	R7	NOTE: PARTS ARE NOMINAL:
15	1		MK2 499	STETTNER	RESISTOR, 499 OHM, 1/4W, 1%	R17	NOTE: FIND NO. 8 CAP, 240PF
16	1		MK2 422		RESISTOR, MF, 422 OHM, 1/4W, 1%	R9	NOTE: FIND NO. 9 CAP, 6800PF
17	1		MK2 681	STETTNER	RESISTOR, 681 OHM, 1/4W, 1%	R8	NOTE: FIND NO. 10 CAP, 82PF
18	1		MK2 27.4	STETTNER	RESISTOR, MF, 27.4 OHM, 1/4W, 1%, 50ppm/C	R2	NOTE: FIND NO. 11 CAP, 47PF
19	1		MK2 2K	STETTNER	RESISTOR, MF, 2K OHM, 1/4W, 1%	R3	NOTE: FIND NO. 13 RES, 909 OHM
20	1		MK2 2.21K	STETTNER	RESISTOR, 2.21K OHM, 1/4W, 1%	R14	NOTE: FIND NO. 14 RES, 619 OHM
21	1		MK2 274	STETTNER	RESISTOR, MF, 274 OHM, 1/4W, 1%, 50ppm/C	R13	NOTE: FIND NO. 16 RES, 422 OHM
22	1		MK2 49.9	STETTNER	RESISTOR, 49.9 OHM, 1/4W, 1%	R12	NOTE: FIND NO. 17 RES, 681 OHM
23	1		MK2 10K	STETTNER	RESISTOR, MF, 10.0K OHM, 1/4W, 1%, 50ppm/C	R1	NOTE: (2) THE FOLLOWING COMPONENT
24	1		031004-001	031004	MICROCIRCUIT, DGTL, 74AC00, NAND, QUAD		U2
25	4		RWR00S1300FR		RESISTOR, WW, 130 OHM, 2W, 1%		R4, R5, R10, R11
26	2		JAN2N2222A		TRANSISTOR, 2N2222A		Q1, Q2
27	1		031006-001	031006	MICROCIRCUIT, DGTL, MC3481, DRVR, QUAD		U4
28	1		021002-014	021002	CONNECTOR, HDR, 14 POS, .025"SQ		J4
29	1		LM317T		VOLTAGE REGULATOR, LM317T		VR1
30	2		LM7805CT		VOLTAGE REGULATOR, LM7805CT		VR2, VR3
31	4		T3220106M035AS	KEMET	CAPACITOR, TANT, 10UF, 35V, 20%		C1, C4, C17, C20
32	1		021002-006	021002	CONNECTOR, HDR, 6 POS, .025"SQ		J1
33	1		021002-008	021002	CONNECTOR, HDR, 8 POS, .025"SQ		J2
34	1		031005-001	031005	MICROCIRCUIT, DGTL, 74AC74, D-FLIP FLOP, DUAL		U1
35	3		021006-001	021006	CONNECTOR, BMC, RTANG, PCB		J5-J7
36	1		4308R-101-103	BOURNS	RESISTOR NETWORK, 10K OHM		RP1
37	3		1N4001		DIODE, 1N4001		CR1-CR3
38	3		MS35338-135	FF-N-84	WASHER, LOCK, SPLIT #4		
39	3		NAS671C4	FF-N-836	NUT, HEX #4		
40	6		NAS620C4L		WASHER, FLAT #4		
41	3		MS51957-14	FF-S-92	SCREW, PAN HEAD, 4-40X5/16		
42	A/R		70411-1	70411	THERMAL JOINT COMPOUND		
43	2		021024-002	021024	CONNECTOR, PLUG, STRIP, 2 PIH		J3, W1
REF				101905	SCHEMATIC, CCA, PRFS		

Parts List, Buffer Board Assembly (PL101907-001)

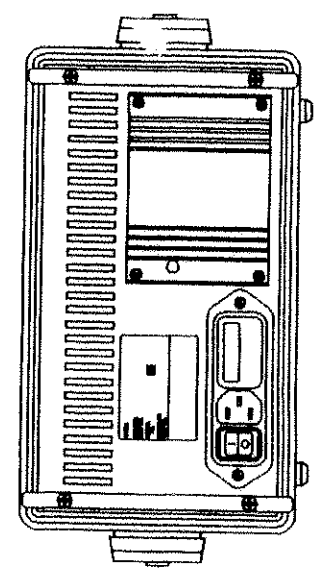
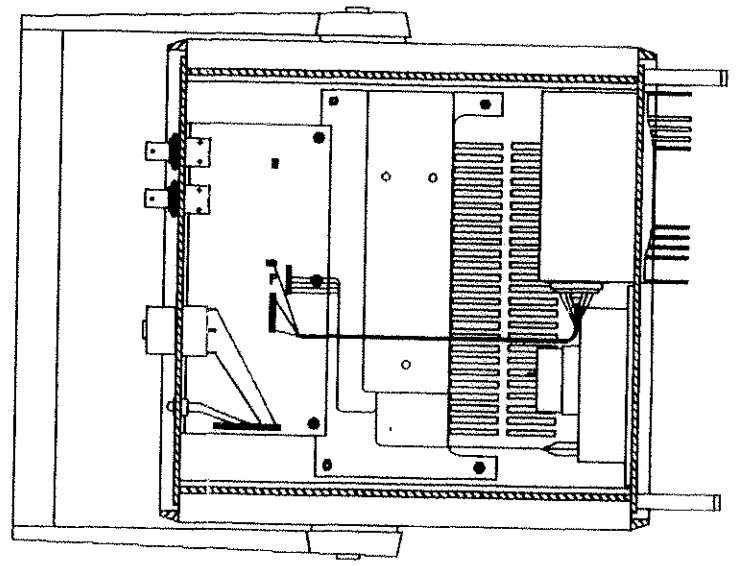
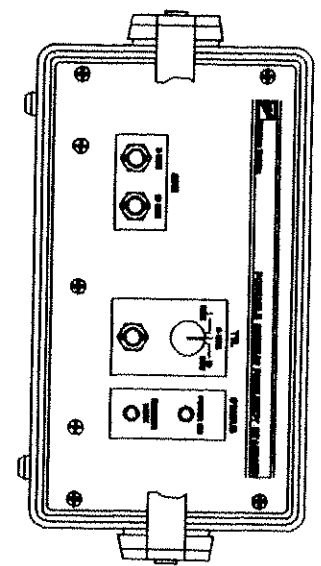

*Portable Rubidium Frequency Standard*

FIND NO.	QTY	CAGE REQ CODE	PART OR IDENTIFYING NO.	SPEC. OR MANUFACTURER	NOMENCLATURE OR DESCR.	HCI REFERENCE CODE DESIGNATOR
1	1		101901-001	101901	CASE, COMPACT	
2	1		024003-001	024003	HANDLE KIT	
3	1		101903-001	101903	PANEL, REAR	
4	2		808-344	808-344	FOOT, CASE, PORTABLE	
5	1		814-152	814-152	HEAT SINK	
6	1		100318-003	100318	FINAL ASSY,FRS,YTL,10MHZ	
7	1		051001-001	051001	SWITCH,PWR ENTRY MODULE,FLTRD	
8	1		101904-001	101904	PLATE,MOUNTING,PWR SPLY,PRFS	
9	1		101914-001	101914	HARNESS ASSY,POWER SUPPLY,PRFS	
10	1		101902-001	101902	PANEL,FRONT	
11	1		101960-001	101960	BRACKET ASSY,PWA MOUNTING	
12	1		101907-001	101907	CIRCUIT CARD ASSY,PRFS	
13	1		101908-001	101908	HARNESS ASSY,FRS,PRFS	
14	1		101929-001	101929	HARNESS ASSY,FRONT PANEL,PRFS	
15	1		024000-001	024000	KNOB,SMOKE	
16	1		808-419-7	808-419-7	LABEL,NAMEPLATE	
17	7		MS51957-14	FF-S-92	SCREW,PAN HEAD,4-40X5/16	
18	4		MS51957-13	FF-S-92	SCREW,PAN HEAD,4-40X1/4	
19	2		MS51957-27	FF-S-92	SCREW,PAN HEAD,6-32X5/16	
20	3		MS24693C46	FF-S-92	SCREW,FLAT HEAD,8-32X1/4	
21	4		70425-27	70425	SCREW,PAN HEAD,M4X12	
22	7		DIN85-A2-M4X8	CAL METRIC	SCREW,PNH,CRES,PHH,M4X8	
23	8		NAS620C4L		WASHER,FLAT #4	
24	4		NAS620C6L		WASHER,FLAT #6	
25	11		70414-10	70414-3/-12	WASHER,LOCK,M4,3	
26	3		AN960C4L	FF-W-92	WASHER,FLAT,#4	
27	11		MS35338-135	FF-W-84	WASHER,LOCK,SPLIT #4	
28	2		MS35338-136	FF-W-84	WASHER,LOCK #6	
29	11		70414-16	70414-13/-17	WASHER,LOCK,M4	
30	1		101915-001	101915	ACCESSARY KIT,PRFS	
31	2		MS35649-264	FF-N-836	NUT,HEX,6-32	
32	2		MP52	WYLE DSTR	HOLDER,LED	
33	2		025008-001	025008	WASHER,LOCK,INT TOOTH,1/2"	
34	3		025007-001	025007	NUT,HEX,1/2"-28,UNEF	
REF				101961	SCHEMATIC,WIRING-BLOCK DIAGRAM	
REF				101913	OUTLINE AND MOUNTING,PRFS	
REF				101911	ACCEPTANCE TEST PROCEDURE,PRFS	
REF				101910	SPECIFICATION,PRFS	
REF				101909	DRAWING TREE,PRFS	

Parts List, Final Assembly PRFS (PL101900-001)



# **APPENDIX B**

## **INSTRUCTION MANUAL**

### **LFS-41 Series Regulated Power Supply**



### LAMBDA EWS50 Power Supply

Specifications for the EWS50 power supply are as follows:

Physical Data:           Weight: 1.10 lbs       Size: 1.38 X 3.82 X 6.02 inches

dc Output:               24 Vdc  $\pm$ 10% adj

Max current at operating temp. at 40°C: 2.4, at 50°C: 2.4, at 60°C: 1.2

Regulation load:       .08%

Ripple & Noise:       250mV pk-pk

Temp. Coefficient:     0.02%/°C

ac Input:

Line:                   85-265Vac, 47-440 Hz

rms Current:

100 Vac input:       1.2

200 Vac input:       .6

Efficiency:             75%

dc Input:               110 to 330 Vdc

Overshoot:             none

Operating Temp. Range: 0° to 60°C

Overload protection:   External overload protection, automatic electronic current limiting circuit

Hold up time:           16 msec

In-rush current limiting:

100 Vac input:       6.8

200 Vac input:       13.5

Overvoltage protection: Non-crowbar, inverting shutdown type standard

Cooling:                Convection

dc Output controls:     Screwdriver adjustment

Input & output connections: Terminal blocks

Isolation rating:       3750V rms input to output; 2500 rms input to ground;  
500v rms output to ground.



DIMENSIONS:

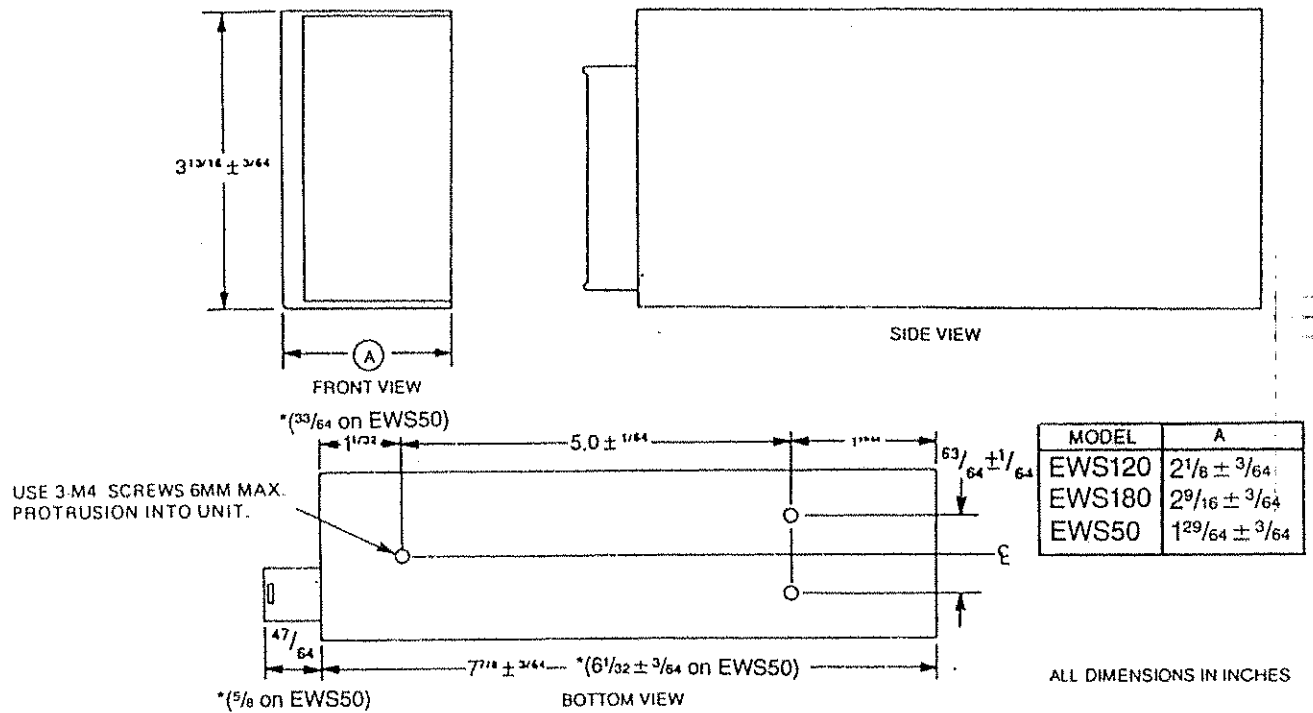

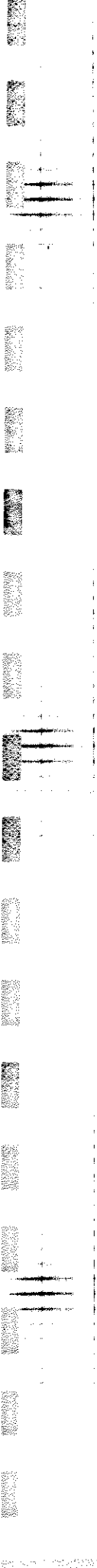



**EFRATOM**

**Time & Frequency Products, Inc.**  
3 Parker, Irvine, CA 92718-1696  
714/770-5000 TELEX 685-635  
FAX 714/770-2463

**5/95**

**Efratom Electronic GmbH**  
Fichtenstrasse 25,  
85649 Hofolding,  
West Germany  
Telephone: 011-49-8104-66240  
FAX: 08104/99 18